

**DURO
DYNE**®

**FLEXIBLE
DUCT
CONNECTOR**

VANE RAIL

$1\frac{3}{4}$ 3 $1\frac{3}{4}$

$2\frac{3}{4}$ 4 $2\frac{3}{4}$

GUARD LOC'

GRIP LOC'

6 3

Distance Vane extends into smaller duct from edge of Duro Dyne Rail

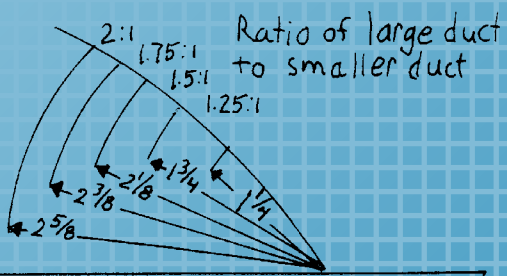

Blade Radius $4\frac{1}{2}$ "

DURO DYNE EAST CORP.
Bay Shore, NY 11706
DURO DYNE MIDWEST
Fairfield, OH 45011
DURO DYNE WEST
Santa Fe Springs, CA 90670
DURO DYNE INTERNATIONAL
Bay Shore, NY 11706

PRE-ASSEMBLED

FLEXIBLE DUCT CONNECTOR ELIMINATES DUCT SYSTEM NOISES AND VIBRATIONS

All air duct installations for heating, cooling or ventilation are attached to mechanical equipment containing a fan or blower. Vibrations, noises and rattles resulting from operation of the fan or blower are transmitted into the metal ducts which carry the noises throughout the system.

In order to isolate the vibration and noises to the source, an air-tight flexible joint, consisting of a fabric which is secured to sheet metal on both sides, must be inserted between the equipment and the ductwork. This flexible joint is called a "Flexible Duct Connector."

To meet every type of installation requirement, whether it be for factory, institution, office or home; Duro Dyne offers the widest variety of flexible duct connector fabrics (U.L. Classified) and sizes - pre-assembled with the sheet metal permanently secured

to the fabric by means of exclusive seam locks. Duro Dyne Flexible Duct Connectors are dispensed from the carton, ready to complete fabrication faster, more efficiently, and more economically than any conventional method.

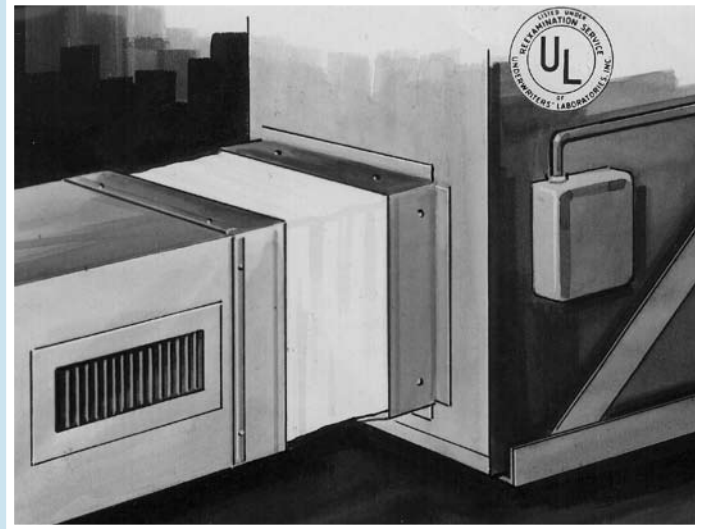

"GRIP LOC"

The double-lock gripping fingers of metal-to-fabrics add tremendously to holding power, compared with conventional singlefold method. **Grip Loc is standard on Metal-Fab and Super Metal-Fab.**

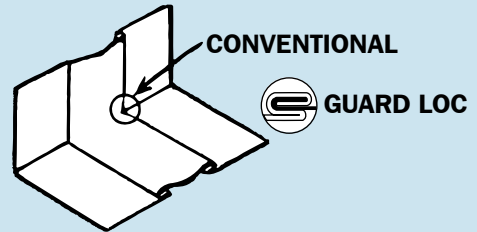
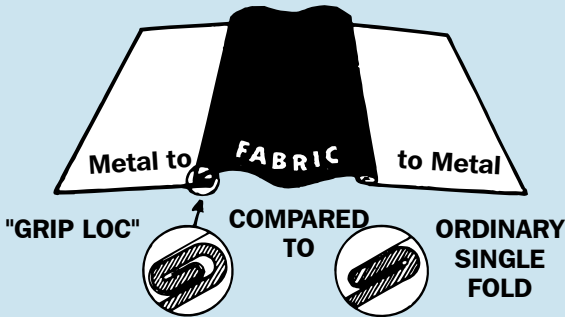

"GUARD LOC"

Another Duro Dyne exclusive. - Shielded with metal on both sides at the seam, Guard Loc forms a tough metal-to-fabric bond. Forming in brake is simpler, and Guard Loc prevents tears in fabric because of unique metal-shielded seams. **Guard Loc is standard in Econ-O-Fab, Junior and Insulflex Connector.**

DUCT FABRICS

(For SPECIFICATIONS please refer to FABRICS on page 3).

| Glasseal | Width | Length |
|---------------|-------|---------|
| #10044 DGL-6 | 6" | 100 ft. |
| #10052 DGL-10 | 10" | 100 ft. |

| Neoprene | Width | Length |
|---------------|-------|---------|
| #10043 DFN-6 | 6" | 100 ft. |
| #10051 DFN-10 | 10" | 100 ft. |

| Thermafab | Width | Length |
|---------------|-------|---------|
| #10045 DFT-6 | 6" | 100 ft. |
| #10053 DFT-10 | 10" | 100 ft. |

| Excelon | Width | Length |
|---------------|-------|---------|
| #10161 DBX-6 | 6" | 100 ft. |
| #10162 DBX-10 | 10" | 100 ft. |

| Durolon | Width | Length |
|---------------|-------|---------|
| #10042 DFD-6 | 6" | 100 ft. |
| #10050 DFD-10 | 10" | 100 ft. |

Canvas, other fabrics & sizes available as special order.

FABRICS

ENVIROFAB

| ITEM | DESCRIPTION | SPECIFICATIONS | FEATURES |
|---------------------|--|---|---|
| #10301 MEV4-100 | Color: Black/White Base Fabric: Polyester | Weight: 18 oz./sq. yd. Tensile Strength: 200 lbs. x 190 lbs. Tear Strength: 60 lbs. x 80 lbs. Low Temp: -40°F High Temp (Continuous): 200°F | <ul style="list-style-type: none"> Environmentally 'Green' Connector Minimum 10% recycled content UV reflective (white side) |
| #10302 JEV-100 | | | |
| #10300 MEV4x4x4-100 | | | |

DYNALON

| ITEM | DESCRIPTION | SPECIFICATIONS | FEATURES |
|---------------------|--------------|---|--|
| #10316 MYL4-100 | Color: White | Weight: 24 oz./sq. yd. Tensile Strength: 280 lbs. x 235 lbs. Tear Strength: 100 lbs. x 100 lbs. Low Temp: -40°F High Temp (Continuous): 260°F | <ul style="list-style-type: none"> Low Cost Substitute for Hypalon Specially formulated for outdoor use. Excellent weather and ozone resistance |
| #10317 JYL-100 | | | |
| #10315 MYL4x4x4-100 | | | |

GLASSEAL UL Classified File# R4462

| ITEM | DESCRIPTION | SPECIFICATIONS | FEATURES |
|----------------------------|--|---|--|
| #10004 MGL Metalfab | Color: Grey & Black Base Fabric: Woven Fiberglass Coating: Vinyl | Weight: 12 oz./sq. yd. Tensile Strength: 90 lbs. x 90 lbs. Tear Strength: 8 lbs. x 9 lbs. Low Temp: -40°F High Temp (Continuous): 180°F | <ul style="list-style-type: none"> Good, low cost Resistant to acids & chemical fumes Resistant to grease & alkalis Unaffected by mildew |
| #10016 MF6G Super Metalfab | | | |
| #10036 EGL Econofab | | | |
| #10029 JGL Junior | | | |

EXCELON® UL Classified File# R4462

| ITEM | DESCRIPTION | SPECIFICATIONS | FEATURES |
|-----------------------------|--|--|---|
| #10159 MBX Metalfab | Color: Black or Spec Chek Orange Base Fabric: Woven Nylon/Polyester Blend Coating: Vinyl | Weight: Commercial Grade - 22 oz./sq. yd. Residential Grade - 17 oz./sq. yd. Tensile Strength: 240 lbs. x 220 lbs. Tear Strength: 100 lbs. x 100 lbs. Low Temp: -40°F High Temp (Continuous): 180°F | <ul style="list-style-type: none"> Excellent water resistance Excellent tear strength Excellent all purpose fabric Unaffected by mildew |
| #10263 MSPX Metalfab | | | |
| #10160 MB6X Super Metalfab | | | |
| #10265 MSP6X Super Metalfab | | | |
| #10171 EBX Econofab | | | |
| #10169 JBX Junior | | | |
| #10210 MBXTDC/TDF 4x4x4 | | | |
| #10264 MSPXTDC/TDF 4x4x4 | | | |
| #10214 MBXTDC/TDF 4x6x4 | | | |

NEOPRENE (STANDARD GRADE) UL Classified File# R4462

| ITEM | DESCRIPTION | SPECIFICATIONS | FEATURES |
|----------------------------|--|---|---|
| #10105 MLN Metalfab | Color: Black Base Fabric: Woven Fiberglass Coating: Neoprene | Weight: 22 oz./sq. yd. Tensile Strength: 500 lbs. x 500 lbs. Tear Strength: 13 lbs. x 13 lbs. Low Temp: -40°F High Temp (Continuous): 200°F | <ul style="list-style-type: none"> Extremely resistant to alkalis & gasoline Excellent on systems exposed to toxic fumes Good general purpose fabric Unaffected by mildew |
| #10148 ML6N Super Metalfab | | | |
| #10035 EFN Econofab | | | |
| #10028 JRN Junior | | | |

NEOPRENE (SPECIFICATION GRADE) UL Classified File# R4462

| ITEM | DESCRIPTION | SPECIFICATIONS | FEATURES |
|----------------------------|--|---|---|
| #10003 MFN Metalfab | Color: Black Base Fabric: Woven Fiberglass Coating: Neoprene | Weight: 30 oz./sq. yd. Tensile Strength: 500 lbs. x 500 lbs. Tear Strength: 13 lbs. x 13 lbs. Low Temp: -40°F High Temp (Continuous): 200°F | <ul style="list-style-type: none"> Extremely resistant to alkalis & gasoline Excellent on systems exposed to toxic fumes Good general purpose fabric Unaffected by mildew |
| #10012 MF6N Super Metalfab | | | |
| #10211 MFN TDC/TDF 4x4x4 | | | |
| #10246 MFN TDC/TDF 4x6x4 | | | |

FABRICS (CONTINUED)

| DUROLON UL Classified File# R4462 | | | |
|-----------------------------------|---|---|---|
| ITEM | DESCRIPTION | SPECIFICATIONS | FEATURES |
| #10002 MFD Metalfab | Color: White Base Fabric: Woven Fiberglass Coating: Hypalon | Weight: 24 oz./sq. yd. Tensile Strength: 250 lbs. x 275 lbs. Tear Strength: 13 lbs. x 13 lbs. Low Temp: -40°F High Temp (Continuous): 250°F | <ul style="list-style-type: none"> •Excellent ozone resistance •Excellent resistance to weathering •Best overall acid resistance •Recommended for rooftop applications •Unaffected by mildew |
| #10011 MF6D Super Metalfab | | | |
| #10034 EFD Econofab | | | |
| #10027 JRD Junior | | | |
| #10237 MFD TDC/TDF 4x4x4 | | | |
| #10245 MFD TDC/TDF 4x6x4 | | | |

| THERMAFAB UL Classified File# R4462 | | | |
|-------------------------------------|---|---|---|
| ITEM | DESCRIPTION | SPECIFICATIONS | FEATURES |
| #10005 MFT Metalfab | Color: Grey Base Fabric: Woven Fiberglass Coating: Silicon Rubber | Weight: 17 oz./sq. yd. Tensile Strength: 200 lbs. x 250 lbs. Tear Strength: 50 lbs. x 40 lbs. Low Temp: -65°F High Temp (Continuous): 500°F | <ul style="list-style-type: none"> •Excellent high temp. resistance •Excellent low temp. resistance •Excellent chemical resistance •Extremely low smoke emission •Excellent ozone resistance •Excellent resistance to weathering •Unaffected by mildew |
| #10013 MF6T Super Metalfab | | | |
| #10037 EFT Econofab | | | |
| #10030 JRT Junior | | | |

- All Duro Dyne Fabrics are designed to meet NFPA 701 (formerly UL 214.)
- All Duro Dyne Fabrics are designed to meet NFPA 90A & 90B.
- All Duro Dyne Fabrics are airtight and waterproof.
- All Duro Dyne Flexible Duct Connector utilize 24 or 28 gauge galvanized steel meeting ASTM-A-525 G60.
- Standard roll length - 100 ft.

NOTE: All specification values shown in Duro Dyne are typical and will vary within accepted commercial tolerances

INDUSTRIAL/COMMERCIAL APPLICATIONS

| METAL FAB | SPECIFICATIONS |
|--|--|
| Metal Fab is constructed of material which meets the requirements of heavy commercial systems. This factory fabricated flexible duct connection will provide for normal vibration "swing" in large duct systems without "short circuiting" the effectiveness of the flexible duct connector. | Gauge: 24 Galvanized |
| | Dimensions: 3" metal - 3" fabric - 3" metal |
| | Fabrics Supplied: Durolon, Excelon, Neoprene, Glasseal, Thermafab |
| | Seam: "Grip Loc" |

| SUPER METAL FAB | SPECIFICATIONS |
|--|--|
| Super Metal Fab is constructed of material to provide for special commercial duct systems. Very large equipment can cause excessive vibration; to compensate for this a wider fabric is used to eliminate the transmission of vibration to the duct. | Gauge: 24 Galvanized |
| | Dimensions: 3" metal - 6" fabric - 3" metal |
| | Fabrics Supplied: Durolon, Excelon, Neoprene, Glasseal, Thermafab |
| | Seam: "Grip Loc" |

| TDC/TDF CONNECTOR | SPECIFICATIONS |
|--|--|
| TDC/TDF Connector has ample material for roll forming a connecting flange on both sides of the flexible connection. This product is designed to be compatible with both TDC (Lockformer) and TDF (Engel) roll forming flange-fabricating machines. | Gauge: 24 Galvanized |
| | Dimensions: 4" metal - 4" fabric - 4" metal |
| | Fabrics Supplied: Durolon, Excelon, Neoprene, Glasseal, Thermafab |
| | Seam: "Grip Loc" |
| | Also Available: 4" metal -6" fabric -4" metal |

RESIDENTIAL/LIGHT COMMERCIAL APPLICATIONS

| ECONOFAB | SPECIFICATIONS |
|---|--|
| For light commercial or larger residential systems. | Gauge: 28 Galvanized |
| | Dimensions: 2 3/4" metal - 4" fabric - 2 3/4" metal |
| | Fabrics Supplied: Durolon, Excelon, Neoprene, Glasseal, Thermafab |
| | Seam: "Guard Loc" |

| JUNIOR CONNECTOR | SPECIFICATIONS |
|--------------------------|--|
| For residential systems. | Gauge: 28 Galvanized |
| | Dimensions: 1 3/4" metal - 3" fabric - 1 3/4" metal |
| | Fabrics Supplied: Durolon, Excelon, Neoprene, Glasseal, Thermafab |
| | Seam: "Guard Loc" |

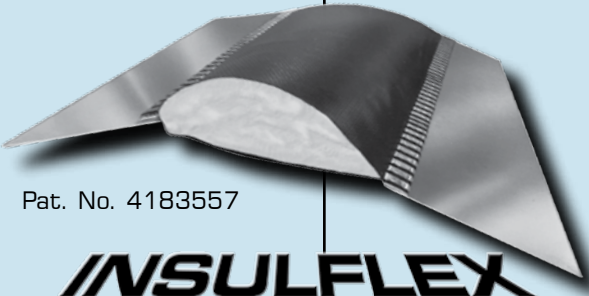
| INSULFLEX | | | |
|--|---|--|---|
| ITEM | DESCRIPTION | SPECIFICATIONS | FEATURES |
| <p data-bbox="152 793 467 825">#10173 IDC 343 INSULFLEX</p>  <p data-bbox="191 1087 412 1119">Pat. No. 4183557</p> <p data-bbox="233 1150 704 1203">INSULFLEX</p> | <p data-bbox="503 793 747 898">Color: Black Base Fabric: Polyester Coating: Vinyl Insulation: Fiber Glass</p> | <p data-bbox="932 793 997 825">Fabric</p> <p data-bbox="782 825 1133 1171">Weight: 9 oz./sq. yd. Tensile Strength: 70 lbs. x 70 lbs. Tear Strength: 8 lbs. x 11 lbs. Low Temp: -40 °F High Temp (Continuous): 180 °F steel Thickness: 28 gauge Galvanized Cooling: 660 Insulation Thickness: 1" Density: 1.34 lbs/cuft Composite Materials: 2 Layers of fabric encapsulating insulation Finished Dimensions: 2 3/4" x 4" x 2 3/4"</p> | <ul data-bbox="1170 793 1539 982" style="list-style-type: none"> • 2 layers of fabric encapsulating • R value of 4.2 • Guard Loc fabric to metal seam • Waterproof • Airtight • Resistant to grease, oil, gasoline and acid |

FABRICATING A FLEXIBLE CONNECTION

HOW TO STIFFEN FLEXIBLE CONNECTOR

When installing large size flexible connectors in a duct system, some type of stiffening agent is usually required to keep the unit relatively rigid. Some contractors use angle iron, while in many cases a bar slip connection is used to achieve this result. Now it is possible to save valuable time and material by forming Duro Dyne's Grip Loc Seam found on Metal Fab and Super Metal Fab, to rigidize the connector over long sections. Here is how it is done: This simple method of stiffening the sides of Duro Dyne Flexible Connector can eliminate the costly addition of angle iron used to perform this job.

Note: The stiffening method illustrated here is recommended only with Duro Dyne Grip Loc Connector.

1. Lay out Connector as you normally do.

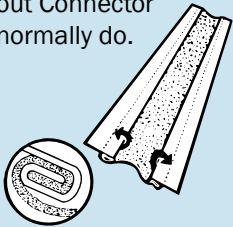

2. Bend Grip Loc seam up to 90° on brake as indicated in drawing.

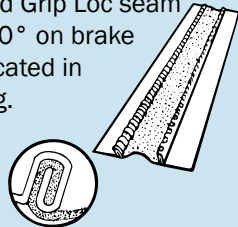

3. Using heavy snips, notch standing seam at bend points.

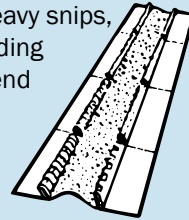

4. Bend to form completed connector.

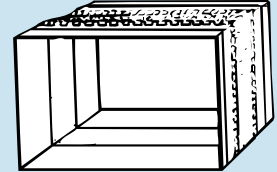

HOW TO SEAM FLEXIBLE CONNECTOR AT CORNER OF CONNECTOR

HERE IS HOW WE SUGGEST THE ENDS OF CONNECTOR BE PREPARED FOR MAKING A JOINT.

TO DO THIS:

1. Cut through center of lock as indicated. Cut 1" to 1 1/2" deep to allow sufficient lap.

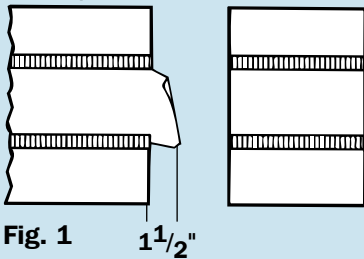

2. From edge of connector, cut away metal as indicated. Metal falls away exposing fabric ready for seaming.

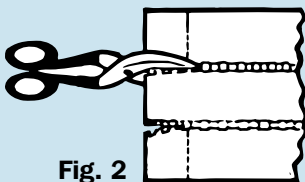

3. You have two options to finish your joint.

A. FCA

B. Duro Stapler with Quad Seal

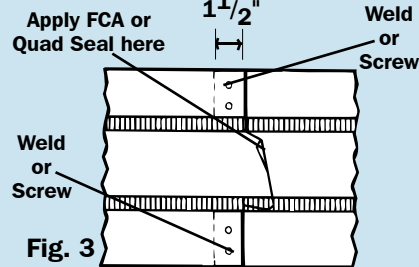

Fig. 3

3A. Apply one or two lines of FCA, sparingly, on fabric, under tongue. Press tongue down on adhesive. Rub gently and hold for 10 seconds. For use with Excelon, Neoprene, Durolon and Glasseal.

FCA Adhesive
1 oz. bottles
Item# 5090

Fig. 3A



3B. Put a liberal amount of Quad Seal between the two fabric flaps & press the two pieces together to allow the Quad Seal to spread out. Roll the flap ends together & staple the seal (going through both pieces of fabric & the Quad Seal). Allow a minimum of 24 hours curing time before flexing the connection. For use with Excelon, Neoprene, Durolon, Thermo-fab and Glasseal.

QS85 Quadseal
8 oz. can
Item# 8159

Fig. 3B



4. For an airtight connection, apply duct sealer over metal joint. Refer to Duro Dyne's Adhesive Duct Sealer Catalog for further information on a suitable Duct Sealer.

Finished Joint

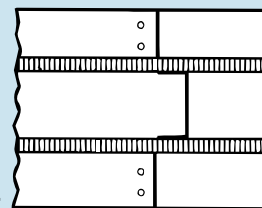
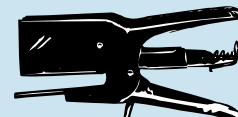

Fig. 4

DURO STAPLER AND STAPLES

Duro Dyne's Flexible Connectors are preassembled metal-to-fabric which eliminates this difficult, time consuming shop operation. After forming the metal, the overlap can be riveted, screwed or spot welded.

Fabric seam is quickly closed using the handy **Duro Stapler**. The result is a sturdily constructed, low cost flexible connector which meets engineering specifications. See **Fabricating A Flexible Connection** above.



ITEM# 10065

DSP-1 STAPLES
For Use With
DS DURO STAPLER
QUANTITY: 5000

ITEM# 10059

VANE RAIL

Duro Dyne Vane Rail, made up of 24 gauge galvanized steel, is precision-stamped and slotted assuring uniform spacing of vanes, and the fastest, easiest, most economical construction of vane assemblies. Duro Dyne Vane Rail is specially embossed adding strength and sturdiness to the finished section, eliminating rattling. Vane Rail can be used to make quality turning vanes for any size elbow including change of size elbows.

Air travelling throughout a duct is slowed up when it reaches a right turn angle. This "slow-up" is detrimental to the efficiency of the duct system, therefore air turning vane assemblies are used to guide air evenly around such turns. With today's high labor costs, it is expensive for shops to produce their own air turning assemblies. That is why Duro Dyne Vane Rail is a major contribution to sheet metal shops that require efficient, yet inexpensive air turning assemblies. With Duro Vane Rail, which is a pre-fab side rail, layout time is eliminated. Vanes can be sheared from scrap metal without tab cutting, and quickly assembled to rails with only one blow of a ball peen hammer.

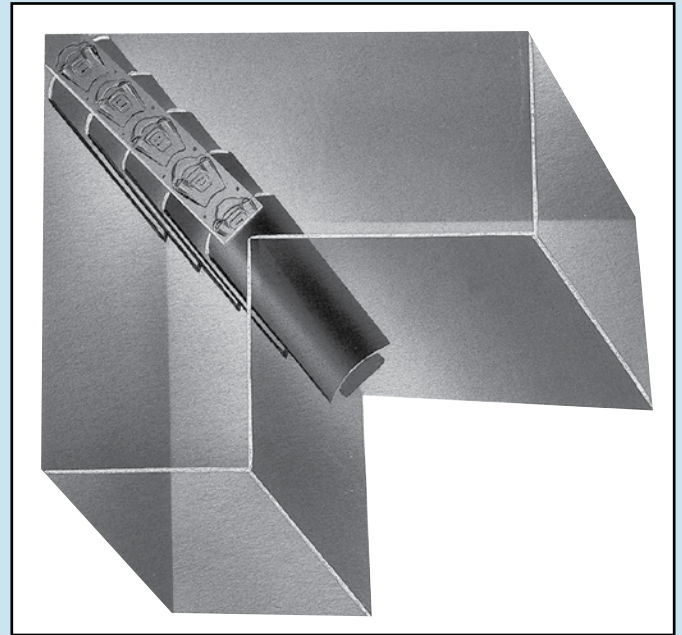

SPECIFICATIONS AND ORDERING

| ITEM | CODE | DESCRIPTION |
|------|-------|--|
| 4002 | VR-2 | Vane Rail - 100 ft. Continuous Coils |
| 4003 | JVR-2 | Junior Vane Rail - Two 100 ft. Continuous Coils (Easily Dispensed Together or Singulary) |

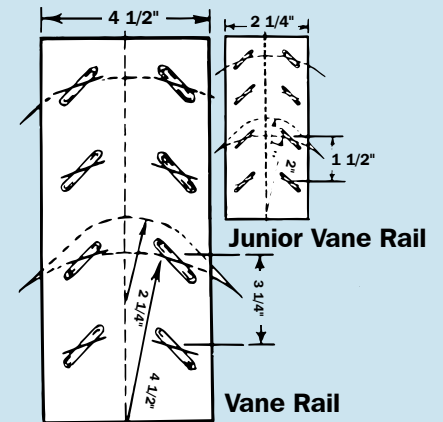

FABRICATING AIR TURNING VANES



Shear and form vanes as indicated. Position vanes in Vane Rail slot. Slots force vanes to take correct curve.



Secure the protruding vane with ball peen hammer.



Extra deep depression in Vane Rail allow for superior gripping action. Vane assembly is then fastened in elbow.

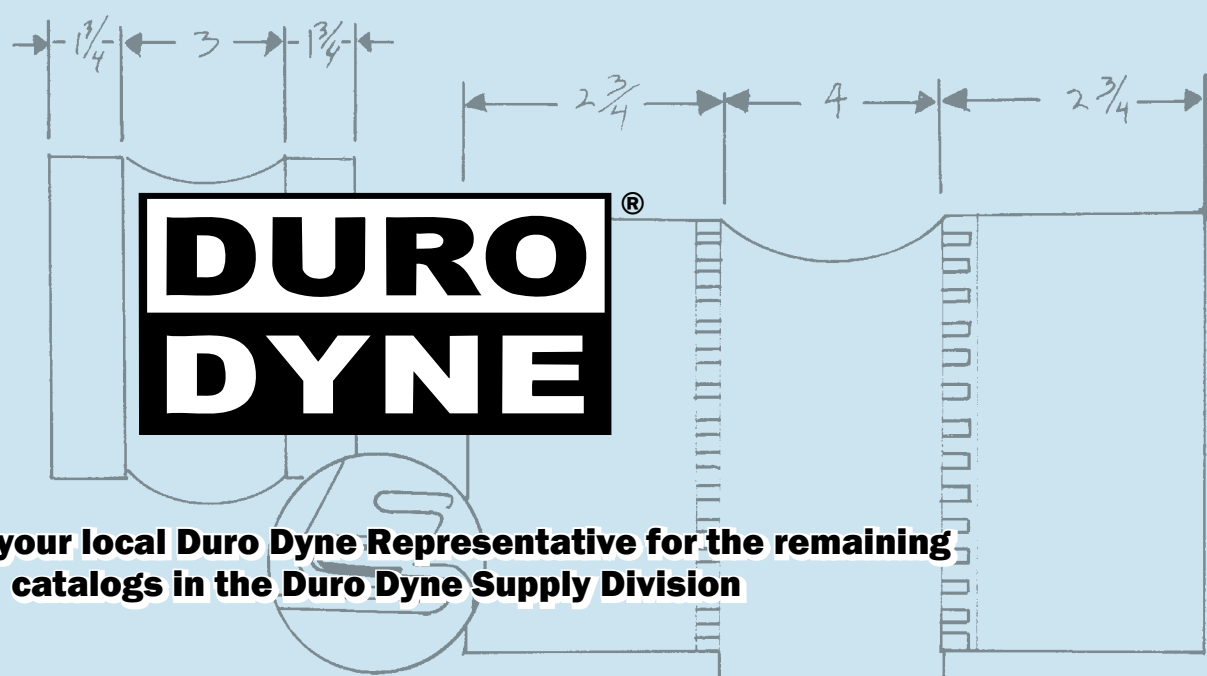

DURO DYNE

Check with your local Duro Dyne Representative for the remaining catalogs in the Duro Dyne Supply Division

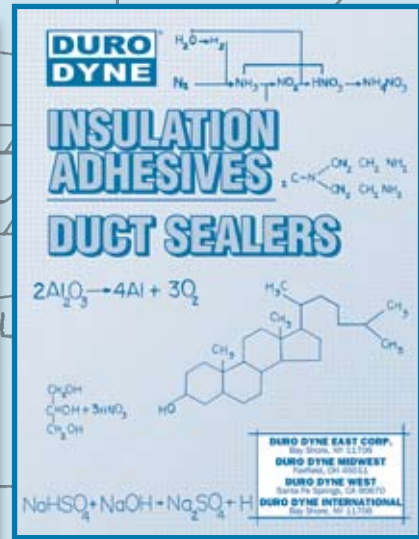
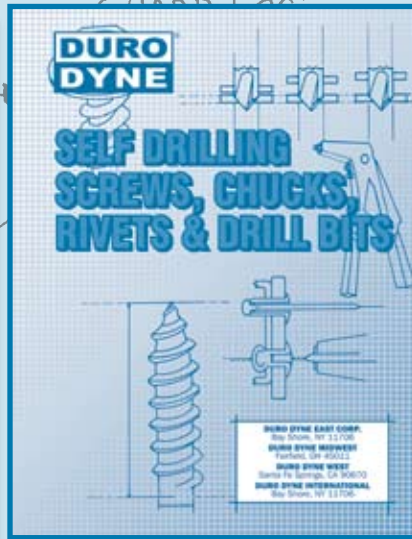
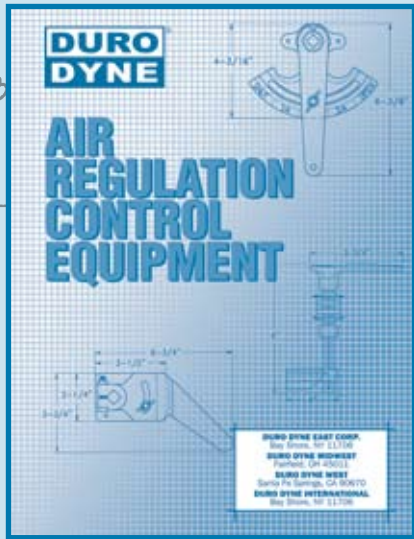

Distance Vane extends into smaller duct from edge of Duro Dyne Rail

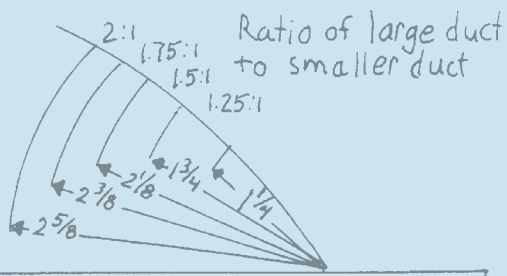

© 2007 Duro Dyne Corp.

| | | |
|---|---------------------|--------------------------|
| Duro Dyne East Division, Bay Shore, NY | 631-249-9000 | Fax: 631-249-8346 |
| Duro Dyne Midwest Division, Fairfield, OH | 513-870-6000 | Fax: 513-870-6005 |
| Duro Dyne West Division, Santa Fe Springs, CA | 562-926-1774 | Fax: 562-926-5778 |
| Duro Dyne Canada, Lachine, Quebec, Canada | 514-422-9760 | Fax: 514-636-0328 |
| www.durodyne.com E-mail: durodyne@durodyne.com | | |